

TRIM PROFILES AND DIMENSIONS (in inches)

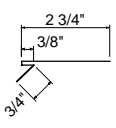

EAVE STARTER

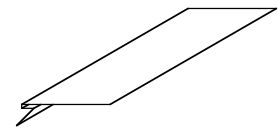
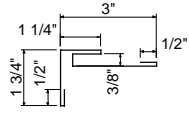
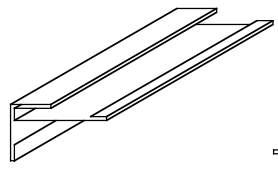

GABLE TRIM

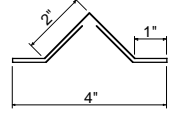
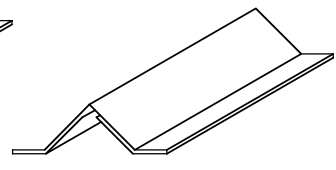

SNOW STOP

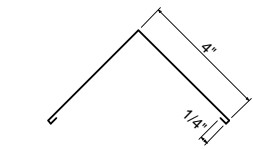
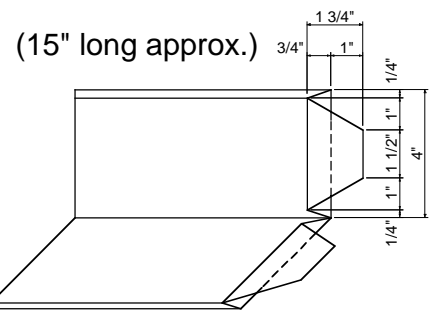

SECTIONAL RIDGE / HIP

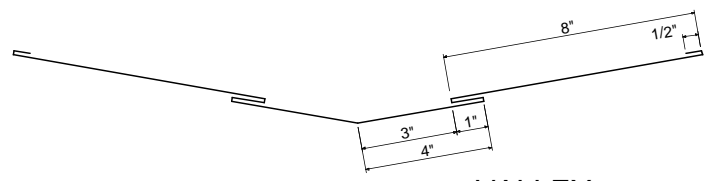
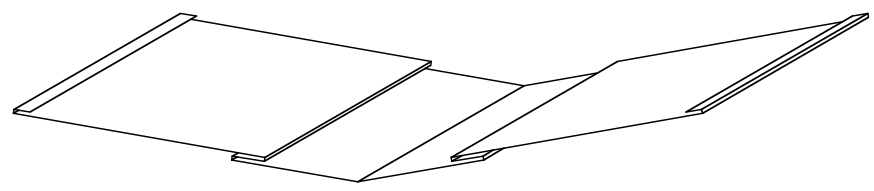

VALLEY

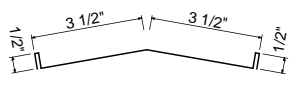
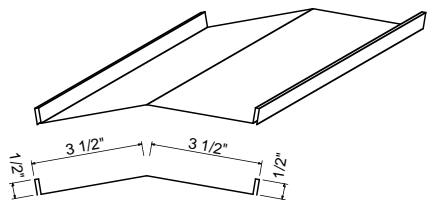

RIDGE / HIP

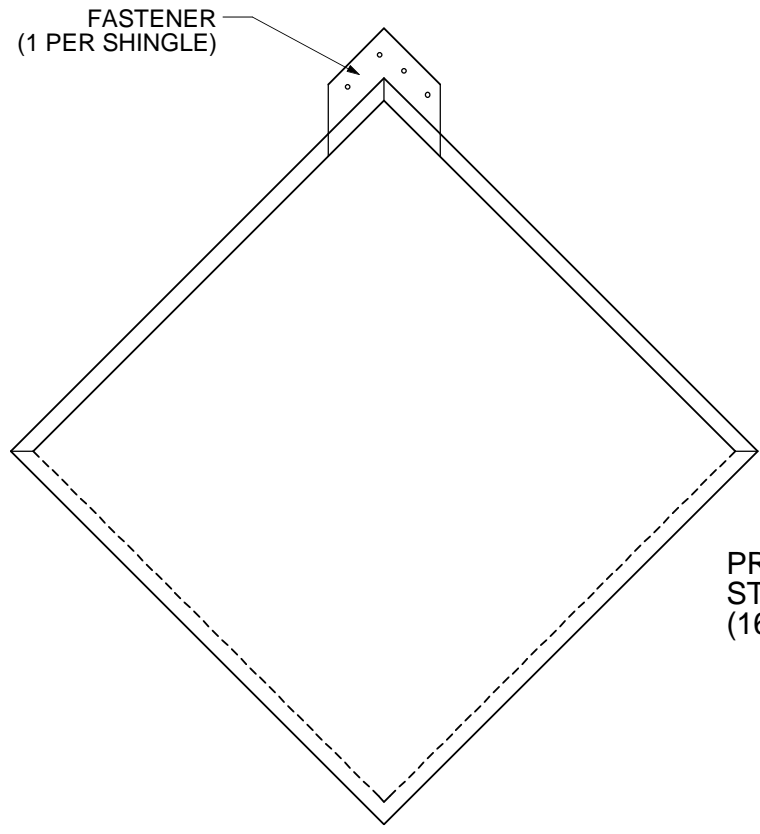

**FASTENER
(1 PER SHINGLE)**

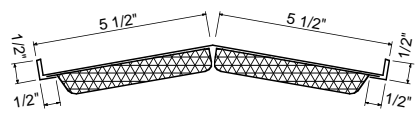
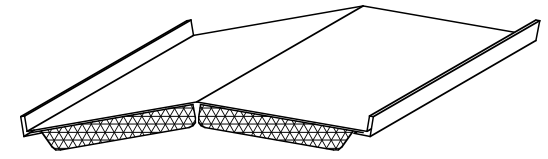

VENTED RIDGE

**PRE-PAINTED
STEEL ROOFING SHINGLE
(16" x 16" approx.)**



Diamond Steel Roofing Systems

R.R. 3, Wingham, ON, N0G 2W0
 1-888-810-ROOF (7663) • (519) 357-3760 • Fax: (519) 357-4627